

## WARRANTY

This KOOLATRON product is warranted to the retail customer for 1 year from date of retail purchase, against defects in material and workmanship.

### WHAT IS COVERED

- Replacement parts and labor.
- Transportation charges to customer for the repaired product.

### WHAT IS NOT COVERED

- Damage caused by abuse, accident, misuse, or neglect.
- Transportation of the unit or component from the customer to Koolatron.

### IMPLIED WARRANTIES

Any implied warranties, including the implied warranty of merchantability are also limited to the duration of 1 year from the date of retail purchase.

### WARRANTY REGISTRATION

Register on-line at [www.koolatron.com](http://www.koolatron.com) AND keep the original, dated, sales receipt with this manual.

### WARRANTY AND SERVICE PROCEDURE

If you have a problem with your MOSQUITO TRAP, or require replacement parts, please telephone the following number for assistance:

**North America 1-800-265-8456**

Koolatron has Master Service Centers at these locations:

#### **Koolatron U.S.A.**

4330 Commerce Dr., Batavia, NY 14020-4102 U.S.A.

#### **Koolatron Canada**

27 Catharine Ave., Brantford, ON N3T 1X5 Canada

A Koolatron Master Service Centre must perform all warranty work.



[www.koolatron.com](http://www.koolatron.com)

©2009 Koolatron, Inc. All rights reserved.  
All specifications are subject to change without notice.

Made in Canada  
Patent pending for Canada & U.S.A.

H1S 068

02/2009-v4

TAKE BACK THE GREAT OUTDOORS

# BITE SHIELD

## MOSQUITO TRAP

### CORDLESS GUARDIAN

Two detailed line drawings of mosquitoes are positioned on either side of the 'BITE SHIELD' title, appearing to fly towards the center.

DOMESTIC  
REG NO. 29240 P.C.P. ACT  
READ THIS GUIDE BEFORE USING

KEEP OUT OF REACH OF CHILDREN

**MK14**  
**OWNER'S MANUAL**

## HOW IT WORKS

The BiteShield Cordless Guardian, MK-14 utilizes the documented attractiveness of carbon dioxide (CO<sub>2</sub>), moisture, body temperature (thermal imaging), color, shape and airflow in an effective design that captures and kills mosquitoes. Similar traps have been in use for years by universities, state monitoring programs and researchers around the world. The BiteShield Cordless Guardian, MK-14 uses this traditional trapping approach, combined with the latest in research, to turn the female mosquito's natural hunting techniques toward seeking out the trap and thus, facilitating their capture in a product that private home owners can use. Another major feature of MK14 is that it is cordless – that is, no electrical or extension cords to deal with! The unit is powered by a patented internal power generated mechanism that uses propane fuel to operate the fan and LEDs. Thus, MK14 eliminates a major safety hazard that users might face while operating such units outdoors.

This is how the female mosquito reacts to the trap: At a fairly long distance (up to 12.2m/40ft. away), it senses the CO<sub>2</sub> and moisture coming from the unit's burner. This tells the mosquito that there is a "breathing" creature around. It flies towards the source of CO<sub>2</sub> and moisture. As it travels, at a range of approx. 4.6m/15ft., it starts to sense temperature similar to that of a living creature (thermal imaging). The unique design of the MK-14 has two different thermal-imaging systems (patents pending): a) static thermal imaging, where in the body of the trap, there is warmth at the top surfaces of the "neck" similar to that of living beings. This temperature is constant and generates consistent heat waves that attract the mosquitoes closer to trap. b) Spot thermal imaging: The black dome-like surface of the trap is warmed up at different points to be similar to living being's temperatures. Live beings do not have a consistent temperature across the body. This sends a message to the mosquitoes saying that this variation of temperatures is similar to a live animal. The top of this area consists of a vacuum air flow caused by the internal fan which pulls the mosquitoes into the trap thanks to the unique design of the internal components of the trap. The vacuum airflow goes straight into the receptacle with grilled openings depositing inside of it all the mosquitoes that were attracted, where they stay trapped until they dehydrate and ultimately die.

## WHERE TO PLACE

Many species of mosquitoes have an adult life span that lasts about two weeks. Approximately 3,000 species of mosquitoes have been identified world-wide. Both male and female mosquitoes feed on plant nectar, but only the female requires a blood meal. The blood feeding is needed for each batch of eggs the female lays, typically feeding once every 3-4 days. If the mosquito is not disturbed, during the biting process, a blood feeding usually lasts about 90 seconds and the amount of blood is 1-1/2 times its body weight. A single female mosquito may lay thousands of eggs, during her lifetime.

The female mosquito is attracted to a host by carbon dioxide (CO<sub>2</sub>), temperature, scent, color, shape, movement and for some species, even sound. The female mosquito is usually most active between 10°C/50°F and 35°C/95°F while in calm or light breeze conditions. Mosquitoes tend to travel up-wind when seeking a blood feeding.

**The placement of the Mosquito Trap will greatly affect the success of the unit's ability to capture mosquitoes.**

The largest amount of mosquitoes will be captured by positioning the mosquito trap 9.1m/30ft. to 12.2m/40ft. away from the location you want to protect, in the normal down-wind direction towards where mosquitoes are living (trees, bushes and water). To find the best starting point in your yard for trap placement, walk about 3-4.6m/10-15ft away from the deck (patio, porch) area that you want to primarily protect. Light a smoky incense and watch which direction the smoke drifts while standing there. Next, move about 1.5-2.4m/5-8ft to the left of the original spot and repeat. Then 1.5-2.4m/5-8ft. to the right of the original spot and repeat. This is all to help you identify the normal airflow pattern. Repeat this procedure at your deck and see if the air movement is in the same direction. You should find a common area of your yard that the air moves toward. This is where you want to place the trap, ideally at a distance of 12.2-15.2m/40-50ft. away from the deck area.

Placing the trap close to shrubs, bushes, or other vegetation can help to increase mosquito capture. Research has demonstrated plants like mint and lemon grass can decrease capture while bushy and leafy plants without strong odor increase capture.

**WARNING: Minimum clearance 61cm/24" to walls or ceilings is required.**

## ACCESSORIES

### PROPANE TANK COVER



- Made of durable outdoor cotton-based, weather-resistant material
- Machine washable in cold water, looks great!
- Designed with sewn-in velcro strips for quick and easy wrap-around installation
- Fits any standard 9.07kg/20lbs. propane tank
- One year warranty

For prices and availability please call: 800-265-8456

## PRECAUTIONS

1. Do not insert foreign objects into this product.
2. The BiteShield Cordless Guardian, MK-14 is for **OUTDOOR USE ONLY**.
3. DO NOT clean the unit by spraying water or by immersing in water.
4. All repairs to the unit must be performed only by qualified service personnel.
5. Read and follow all instructions affixed to the propane tank.
- 6. Young children should be carefully supervised when they are in the area of the BiteShield Cordless Guardian, MK-14.**
- 7. Clothing or other flammable materials should not be hung from the unit or placed on or near it.**
- 8. Any guard or other protective device removed for servicing the BiteShield Cordless Guardian, MK-14 must be replaced prior to operating.**
9. It is imperative that the compartment, burner and circulating air passage ways of the BiteShield Cordless Guardian, MK-14 be kept clean at all times.
10. A maximum of a 9.07kg/20lbs propane tank must be used with the BiteShield Cordless Guardian, MK-14.
11. The propane tank must be provided with a shutoff valve terminating in a propane supply tank valve outlet specified for Connection No. 791 in the Standard for Compressed Gas Cylinder Valve Outlet and Inlet Connections, ANSI/CGA-V-1-latest edition (Any standard 20lb/9.07kg Propane tank manufactured in the USA after 1999).
12. The propane tank supply system must be arranged for vapor withdrawal and the tank must include a collar to protect the tank valve.
13. The propane tank used shall be constructed and marked in accordance with the specifications for propane tanks of the U.S. Department of Transportation (DOT).
14. The BiteShield Cordless Guardian, MK-14 must be used outdoors and only in a well ventilated space and shall not be used in a building, garage or any other enclosed area.
15. The BiteShield Cordless Guardian, MK-14 should be stored indoors when not in use and kept away from children.
16. The propane tank must be disconnected and removed from the unit, if the appliance is stored indoors.
17. Propane tanks must be stored outdoors in a well ventilated area out of the reach of children. Disconnected cylinders must have a plastic cap installed and must not be stored in a building, garage or any other enclosed area.
18. The pressure regulator and hose assembly supplied with the BiteShield Cordless Guardian, MK-14 must be used for connection to the propane tank. Replacement pressure regulators and hose assemblies must be purchased from Koolatron, Inc.

## WHAT TO EXPECT

To achieve the best results from your BiteShield Cordless Guardian, MK-14, you must leave it in operation full-time during the mosquito season. The trap is not meant for occasional use, such as during an outdoor party.



## WARNING

**This product is fueled by propane gas, which is invisible, odorless and highly flammable. An odorant is normally added by the manufacturer, which has a "rotten egg" smell to it. This additive can fade over time, so leaking gas is not always detectable by smell alone.**

**Propane gas is heavier than air and leaking propane will sink to the lowest possible level. It can be ignited by a spark or flame of any kind and from several feet away from a leak.**

**Do not use a propane tank with a capacity larger than 20lb (9.07kg). The propane tank must be provided with a shut-off valve, arranged for vapor withdrawal and include a collar to protect the tank's valve.**

**Propane gas should be stored or used in compliance with local ordinances or codes with ANSI/NFPA 58. Make sure the propane gas control valve is turned off when not in use.**

**The propane tank must always be stored outdoors, in a well ventilated area and out of the reach of children. Never store propane in an enclosed space (house, garage, etc.).**

**The pressure regulator and hose assembly supplied with the BiteShield Cordless Guardian, MK-14 must be used for the connection to the propane tank. The maximum inlet gas supply is less than 30 SCFH (0,85 cm<sup>3</sup>/h). Replacement pressure regulator and hose assemblies must be provided by Koolatron, Inc.**

**The BiteShield Cordless Guardian, MK-14 must be used outdoors and only in a well ventilated area. If it is stored indoors, disconnect the propane tank and properly store it outdoors. The disconnected tank must have a threaded valve plug tightly installed.**

## FOR YOUR SAFETY

- 1. If you smell propane:**
  - a. Shut off gas valve on tank.**
  - b. Extinguish any open flame.**
  - c. If odor continues, immediately call your gas supplier.**
- 2. Do not store or use gasoline or any other flammable vapors and liquids in the vicinity of the mosquito trap or any other appliance.**
- 3. The installation must conform with local codes or, in the absence of local codes, with the National Fuel Gas Code, ANSI Z223.1-1998 for US and with the CAN1-B149 for Canada.**

## PARTS LIST

Look carefully between all packaging internal dividers for parts.

### PARTS

- (A) Main Unit
- (B) Catch Lid
- (C) Support Pole Assembly
- (D) Base with Wheels
- (E) Mosquito Catch
- (F) Regulator with Hose
- (G) Propane Tank (not included)
- (H) Octenol Attractant
- (I) Locking Pin
- (J) "C" size batteries required  
(4 required, not included)

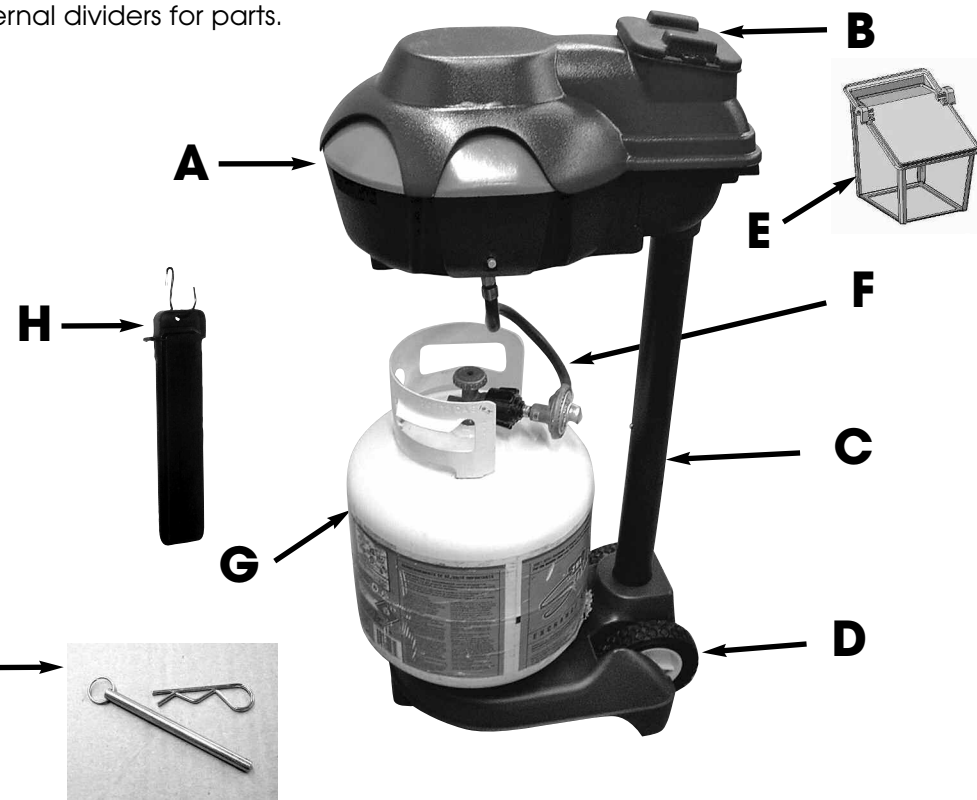

## INSTRUCTIONS FOR OCTENOL MOSQUITO ATTRACTANT

1. Cut foil pack open using scissors. *See Illustration A.*
2. Remove Octenol cartridge from foil pack.
3. Connect "S" hook to Octenol cartridge. *See Illustration B.*
4. Connect other side of "S" hook to trap. *See Illustration C.*  
Put larger end of "S" Hook through hole of the Octenol Cartridge
5. Wash hands thoroughly.

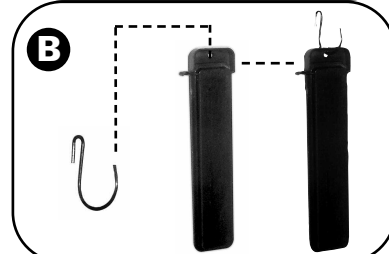
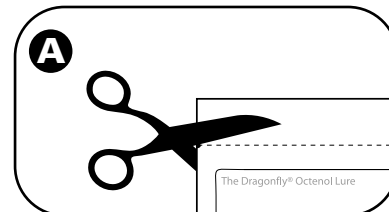

Please see package for cautions and instructions.

To order more Octenol cartridges please visit a retailer near you or visit us at:  
[www.koolatron.com](http://www.koolatron.com)

## TROUBLESHOOTING

Before calling Customer Service, please refer to this chart of possible solutions to the problem.

PROBLEM	POSSIBLE CAUSE	SOLUTION	REFER TO PAGE
Smell of gas coming from unit before starting. DO NOT START THE UNIT WHEN THERE IS GAS SMELL AROUND THE UNIT!!!	<ul style="list-style-type: none"> <li>• Regulator hose not connected properly to Tank</li> <li>• The Regulator's connector is defective</li> </ul>	<ul style="list-style-type: none"> <li>• Shut off Tanks' valve completely. Remove hose and re-connect making sure the threaded connector goes in easy and can be tightened well. If the threading doesn't go in easy, either: The Tank thread is damaged - Replace tank</li> <li>• Call Customer Service</li> </ul>	6 & 8
Red light doesn't turn on when pressing and releasing the power button	<ul style="list-style-type: none"> <li>• No batteries in the battery compartment</li> <li>• Old batteries installed</li> <li>• Batteries are placed backwards</li> <li>• Other</li> </ul>	<ul style="list-style-type: none"> <li>• Check that batteries are installed in the battery compartment</li> <li>• Ensure that you have good "fresh" batteries installed</li> <li>• Make sure that the positive and negative ends of the batteries are properly arranged</li> <li>• Call Customer service</li> </ul>	5
Red light goes on but flame does not start	<ul style="list-style-type: none"> <li>• Gas tank empty</li> <li>• Gas tank not connected to unit</li> <li>• Gas tank valve off</li> <li>• Not holding pressed the valve (silver) safety button while pressing the red igniter button</li> <li>• Unit is tilted</li> <li>• Other</li> </ul>	<ul style="list-style-type: none"> <li>• Replace tank</li> <li>• Connect the hose of the unit to the tank</li> <li>• Make sure that the valve is open as explained in this manual</li> <li>• Make sure the valve (silver) safety button is kept pushed in while pressing repeatedly the red igniter button</li> <li>• Place unit on level surface.</li> <li>• Call Customer service</li> </ul>	6 & 7
Red light stays on, blue flame is on but flame goes off after releasing the Valve (silver) safety button	<ul style="list-style-type: none"> <li>• The valve (silver) safety button is released before the safety mechanism warms up enough to keep the gas flow open</li> <li>• The unit is tilted or not in a horizontal level ground</li> <li>• Other</li> </ul>	<ul style="list-style-type: none"> <li>• Wait 60 seconds and repeat start up procedures and make sure you wait at least 30 seconds before releasing the Valve (silver) safety button</li> <li>• Your MK-14 has a safety switch that shuts off the gas glow if the unit is not horizontal or within 10° tilt from level ground. Look for more level ground where to place the unit and repeat Start Up procedure</li> <li>• Call Customer service</li> </ul>	6 & 7
Red light stays on, blue flame stays on, but blue lights do not go on after 5 minutes	<ul style="list-style-type: none"> <li>• Other</li> </ul>	<ul style="list-style-type: none"> <li>• Turn off the unit and Call Customer Service</li> </ul>	12
Low mosquito catch.	<ul style="list-style-type: none"> <li>• Mosquito population is low due to draught conditions or too cold or hot weather</li> <li>• Mosquitoes dry off and break into tiny pieces going through catch and blown away from unit</li> <li>• Top Lid not properly closed</li> <li>• Catch cover placed backwards</li> </ul>	<ul style="list-style-type: none"> <li>• Keep unit running through all of the season and keep monitoring catch.</li> <li>• One teaspoon of mosquitoes is about 800 female mosquitoes caught and which will not hatch eggs for the season. This lowers your mosquito overall mosquito population and is normal operation. Keep unit running.</li> <li>• Ensure that the Top Lid is properly assembled to avoid vacuum loss in the system.</li> <li>• Make sure you follow the instructions in this manual to install the Catch Cover properly</li> </ul>	8

## SHUTTING OFF

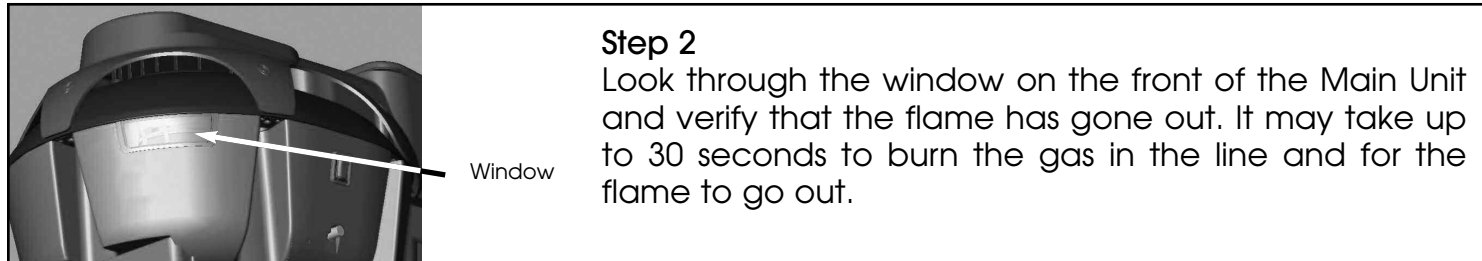
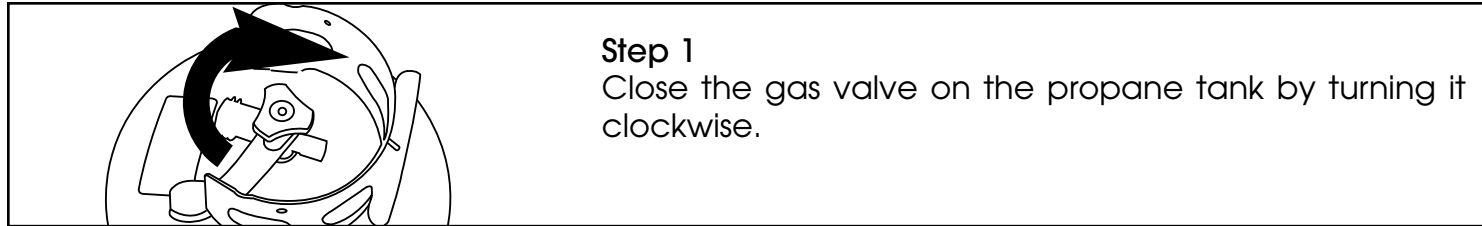

## MAINTENANCE

1. Check the catch on a regular basis. The catch cup is located under the catch lid. Lift the corner tabs of the lid to open and lift the catch cup out. When placing back the Top Lid ensure the orientation is as shown in the picture and make sure that it snaps onto the Top Lid opening ALL AROUND. Failure to place the lid properly will reduce the suction of the unit and the actual mosquito catch. Start by checking the trap twice a week and adjust according to the catch. Use only clean water to rinse the catch, do not use any chemical or soap as the fragrance may repel mosquitoes from the trap. In many cases, the large amount of airflow through the catch, grinds captured mosquitoes against the metal mesh, breaking them into small pieces, which are then blown through the screen.

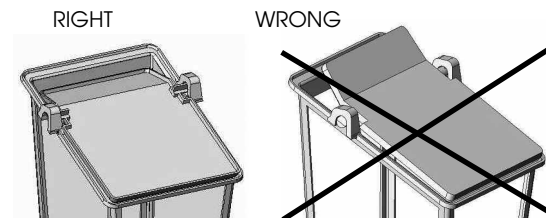
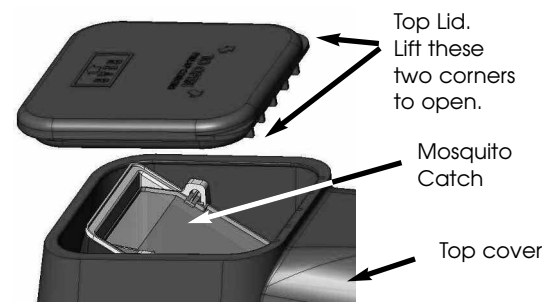

Important: If you remove the catch lid, make sure you snap it back in place as show in this picture . (Shiny surface goes facing down)

2. Refill the propane tank, as necessary when using continuously. Turn off the gas valve and disconnect the regulator hose from the tank. Replace the tank and reconnect the hose.
3. Keep the area around the BiteShield Cordless Guardian, MK-14 clear and free from combustible materials, gasoline, and any other flammable vapors and liquids.
4. Keep the propane tank enclosure area free and clear from debris.
5. Clean the unit outside surface with a mild detergent and a damp cloth. Do not spray with or immerse any part in water.
6. Replacement parts (Regulator with hose, Catch) are available from Koolatron, Inc.
7. Store the unit in a cool dry place when not in use and **AWAY FROM ANY CHEMICALS.**

## ASSEMBLY

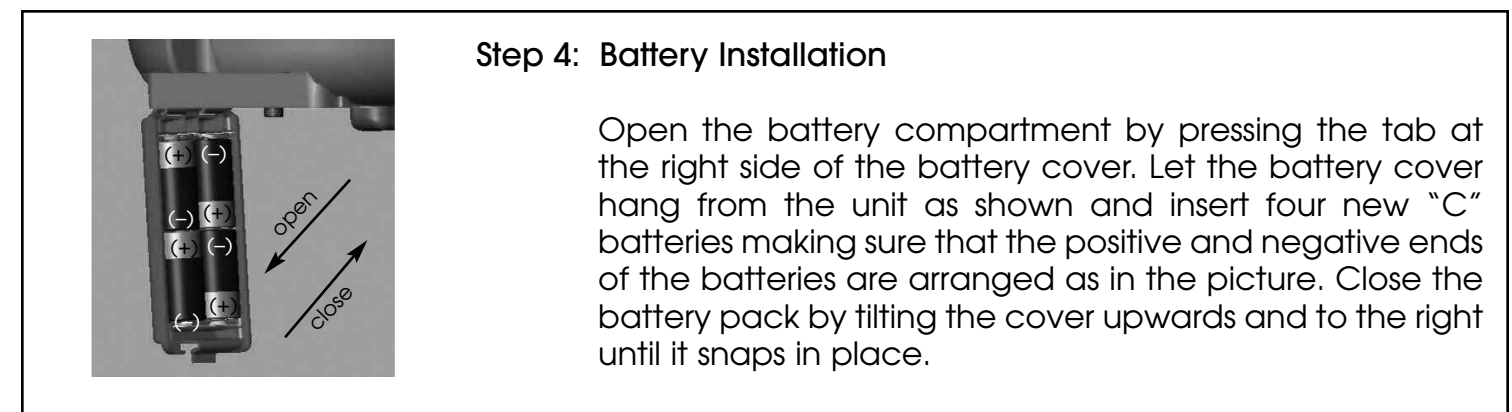
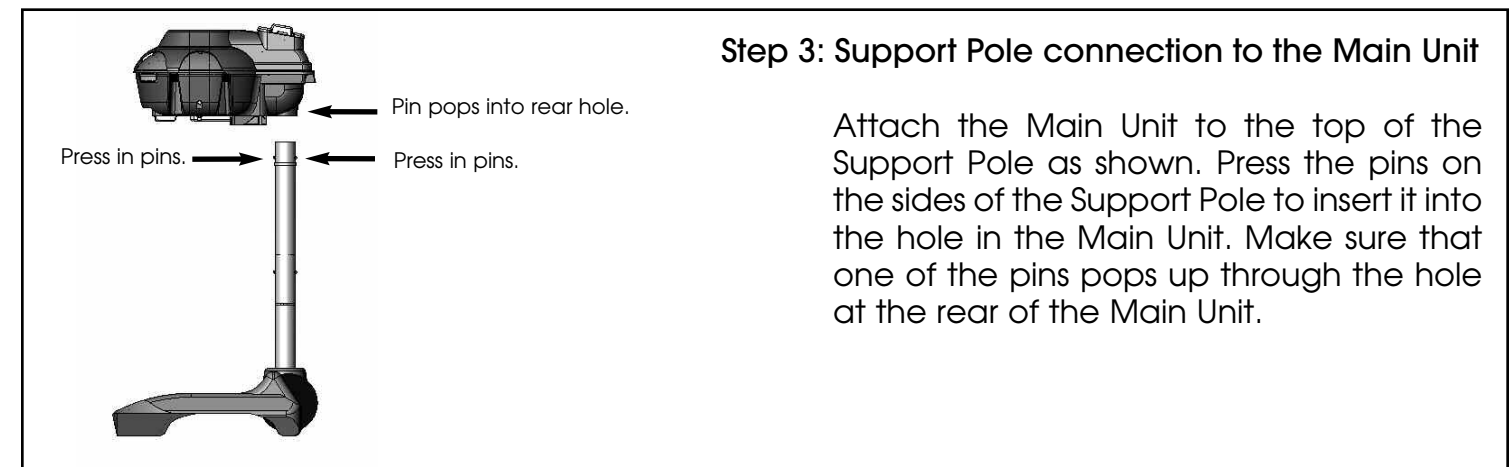
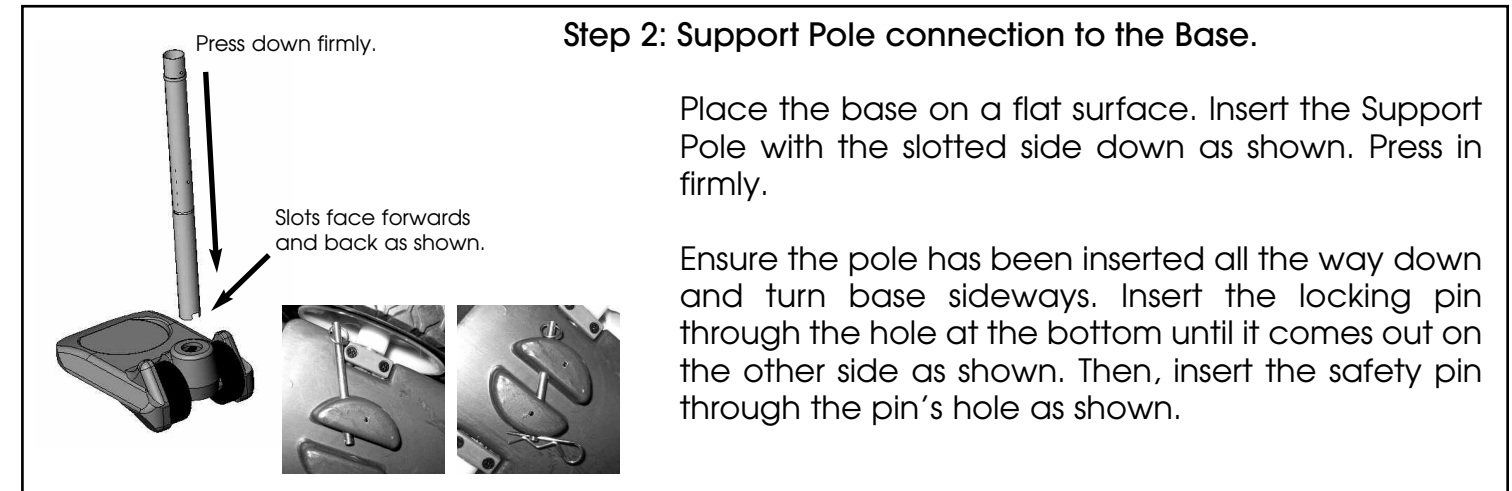
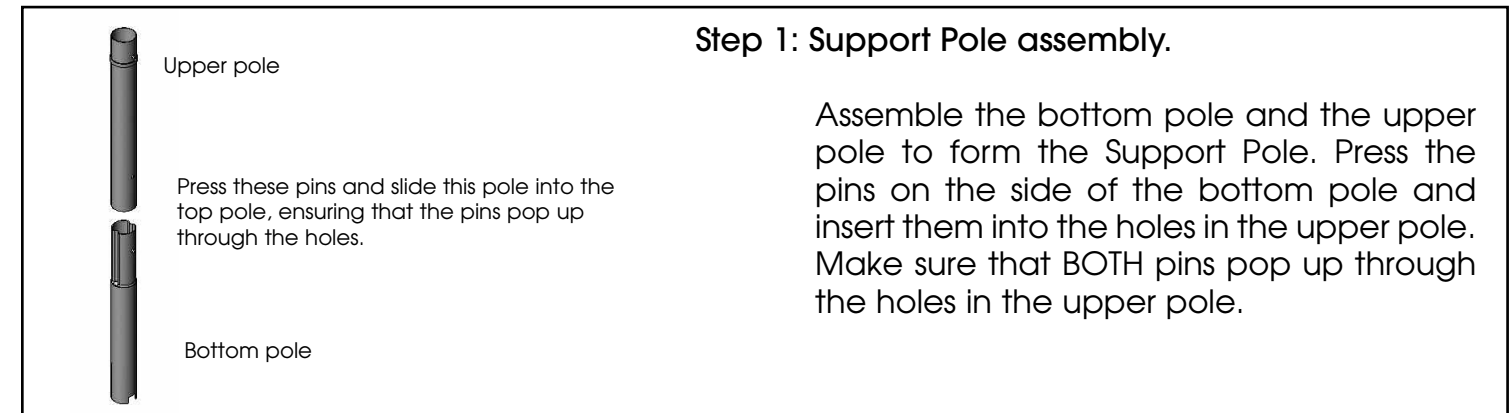

## ASSEMBLY (cont...)

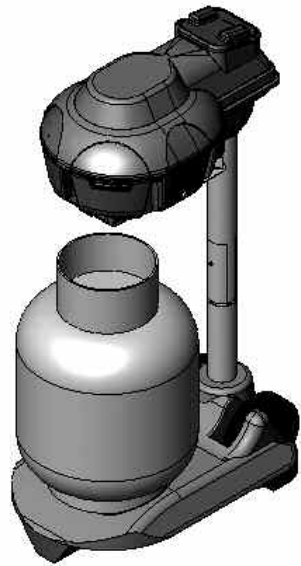

Step 5: Placement of the Propane Tank.

*Do not use a Propane Tank larger than 9.07kg/20lbs*

Place a full tank of propane on the base as shown. Screw the free end of the regulator hose onto the propane tank valve.



### IMPORTANT

Your BiteShield Cordless Guardian, MK-14 is equipped with a Safety Tilt Switch, which shuts off the gas flow if the unit is tilted more than 10°. Make sure your unit is positioned in level ground as much as possible. Otherwise, you won't be able to get the unit to operate continuously.

**WARNING:** Follow the safety information listed on the tank.

## STARTING

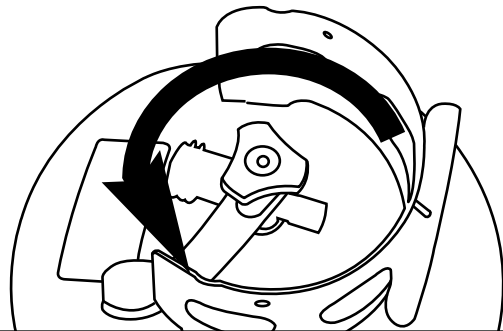

### Step 1

Open the gas valve on the tank to the full open position by turning it counterclockwise until the knob stops rotating.

### Step 2

Press the START switch on the side of the main body. This activates the heater and the vacuum fan. You should see a red light through the window.

### Step 3

Press and hold the valve safety (silver) button, while looking through the Window into the main unit.

### Step 4

Press/click the (red) igniter button repeatedly (located on the underside of the main unit) until a blue flame appears directly in front of you, approximately at the top center inside the unit. If the flame doesn't appear the first time, keep clicking the Igniter button several times while keeping pressed the valve safety button until you see a flame, up to 10 seconds maximum trial period.

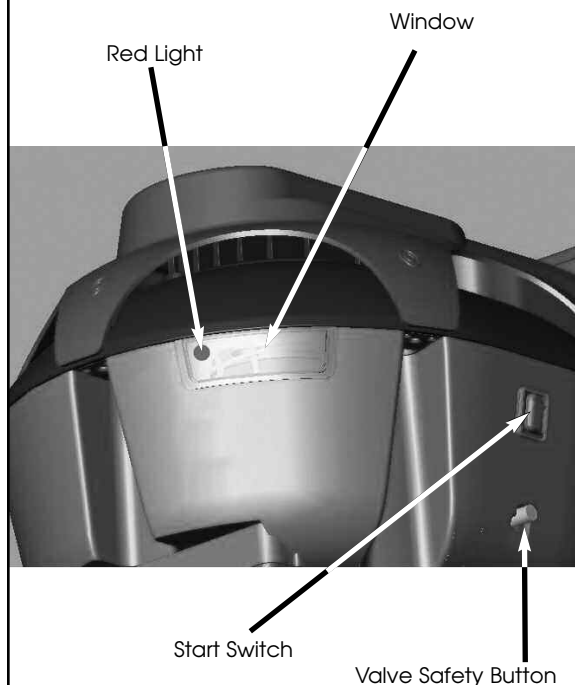

## STARTING (cont...)

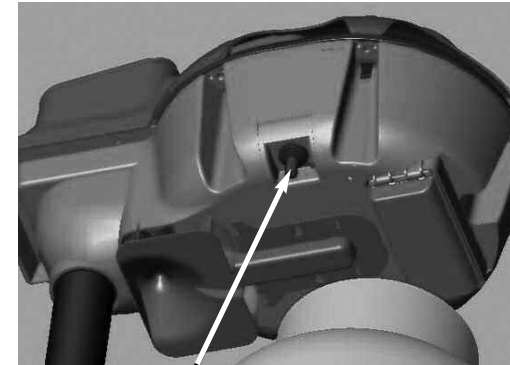

Igniter Button.  
Press/Click repeatedly until the flame starts

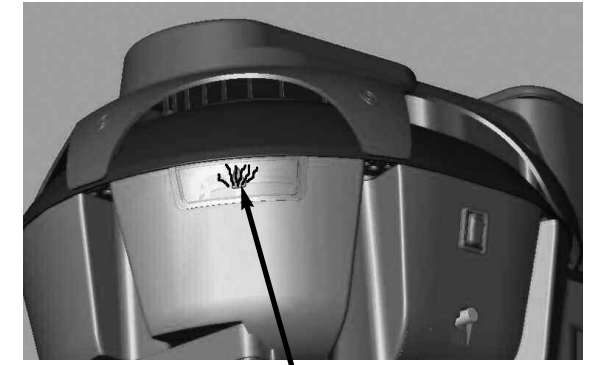

Blue Flame

### IMPORTANT

- Once the flame starts, stop pressing the red igniter button but continue to hold the valve (silver) safety button in for 30 additional seconds after the initial ignition. Then release valve safety button.
- Your MK-14 is equipped with a Safety Tilt Switch, which shuts off the gas flow if the unit is tilted more than 10° from horizontal ground. Make sure your unit is positioned in leveled ground as much as possible. Otherwise, you won't be able to get the unit to operate continuously.

### WARNING

If the unit does not light within approximately 10 seconds, release the gas button and always wait 60 seconds between lighting attempts to allow un-burnt gas to dissipate. Repeat steps 2 through 4 if the burner goes out. There is a safety device that must warm up enough to allow gas to the burner after the safety button is released. (No longer pushed in).

**Note** - When installing a new or refilled propane tank, it may take up to 30 seconds for the gas to reach the burner.

### Step 5

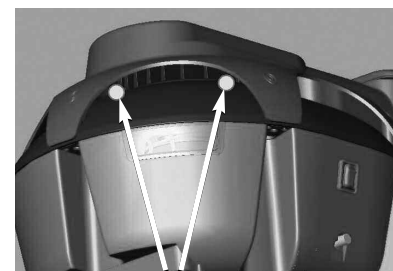

Blue Lights  
under top cover

After the flame is established and you have released all the buttons, watch the trap for another 3-5 minutes until you see the blue lights emitting from under the top cover. This indicates that the unit is in standard operating mode now.

Make sure that the blue lights stay on for at least 2-3 minutes before you leave the trap unattended. This would confirm that the unit is functioning properly. If you don't see blue lights on, turn off the gas tank valve, wait 60 seconds and re-start following steps 1 to 5. If you still don't see the blue light, contact an authorized service personnel. Do not attempt to disassemble and/or repair the unit yourself.

### Step 6

Leave the unit on. It will operate for 4 to 6 weeks continuously capturing mosquitoes on a single tank of propane depending on environmental conditions.